

PCE Americas Inc.
711 Commerce Way
Suite 8
Jupiter
FL-33458
USA
From outside US: +1
Tel: (561) 320-9162
Fax: (561) 320-9176
info@pce-americas.com

PCE Instruments UK Ltd.
Units 12/13
Southpoint Business Park
Ensign way
Hampshire / Southampton
United Kingdom, SO31 4RF
From outside UK: +44
Tel: (0) 2380 98703 0
Fax: (0) 2380 98703 9
info@pce-instruments.com

www.pce-instruments.com/english
www.pce-instruments.com

Manual Colorimeter PCE-CSM 1, PCE-CSM 2 and PCE- CSM 4



Contents

1	Introduction	3
2	Safety notes	3
3	Specifications	4
3.1	Technical specifications	4
3.2	Contents of delivery	4
4	System description	5
4.1	Button description	5
4.2	Interface description	5
4.3	Battery	6
4.4	Changing the measuring aperture (only PCE-CSM 1)	7
5	Operation	8
5.1	Turn on the device	8
5.2	Taking a measurement	8
5.3	Additional functions	10
5.3.1	Record	10
5.3.2	Calibration	11
5.3.3	Connection to a PC or printer	11
5.3.4	Tolerances	12
5.3.5	Delete recorded data	12
5.3.6	Averaging	12
5.3.7	Display mode	13
6	Settings	13
6.1	Colour offset	13
6.2	Language	13
6.3	Time setting	13
6.4	Contrast	14
6.5	Restore factory settings	14
7	Optional Accessories	15
7.1	Powder test box PCE-CSM PTB	15
7.1.1	Build-up	15
7.1.2	Operation	15
8	Contact	16
8.1	PCE Instruments UK	16
8.2	PCE Americas	16

1 Introduction

Thank you for purchasing a PCE-CSM series colorimeter from PCE Instruments.

The colorimeters PCE-CSM 1, PCE-CSM 2 and PCE-CSM4 are the ideal measuring devices for quality control and offer great reliability when you need to comply with certain optical requirements. The colorimeters have an ergonomic design and are equipped with a user-friendly operator interface. The difference between the 3 devices is the size of their measuring apertures.

2 Safety notes

Please read this manual carefully and completely before you use the device for the first time. The device may only be used by qualified personnel and repaired by PCE Instruments personnel. There is no warranty of damages or injuries caused by non-observance of the manual.

- This colorimeter is a precise measuring device. Please avoid strong changes in the environmental conditions. This includes flickering lights as well as changes of the air temperature or air humidity.
- The device may only be used in the approved temperature range.
- Make sure the device is standing right on the measuring spot. Do not move it while the measuring procedure is in progress. Avoid shocks.
- Do not expose the device to water. Only use it in areas which fulfil the permitted environmental conditions.
- Keep the device clean and prevent dust or other particles from entering the measuring aperture. To clean the device, use a damp cloth. Do not use solvent-containing materials for cleaning.
- The case should only be opened by qualified personnel of PCE Instruments.
- You must not make any technical changes to the device.
- The instrument should never be placed with the user interface facing an object (e. g. keyboard side on a table).
- If you do not need the device for a longer period of time, please reset the white calibration and store it in the carrying case.

This manual is published by PCE Instruments without any guarantee.

We expressly point to our general guarantee terms which can be found in our general terms of business.

If you have any questions please contact PCE Instruments.

3 Specifications

3.1 Technical specifications

	PCE-CSM 1	PCE-CSM 2	PCE-CSM 4
Measuring aperture	4 mm	8 mm	20 mm
Geometry	8/d	45°/0	
Sensor	Silicon photoelectric diode		
Colour space	CIEL*a*b*C*h CIEL*a*b CIEXYZ		
Colour difference formula	ΔE^*ab ΔL^*ab ΔE^*C^*H		
Light source	D65		
Light source device	LED blue light		
Errors between each equipment	$\leq 0.50 \Delta E^*ab$		
Storage	100 standard samples, 20,000 test samples		
Repeatability	Standard deviation within ΔE^*ab 0.08 Measurement conditions: average of 30 measurements of standard white plate		
Power supply	Rechargeable lithium-ion battery 3.7 V @ 3,200 mAh		
Charging time	8 hours		
Battery life	Approx. 5,000 measurements		
Lamp life	5 years, more than 1.6 million measurements		
Storage conditions	Air temperature: 0 ... +40 °C Air humidity: 0 ... 85 % RH, non-condensing		
Dimensions	205 x 67 x 80 mm		
Weight	500 g		

3.2 Contents of delivery

- 1 x colorimeter PCE-CSM 1, PCE-CSM 2 or PCE-CSM 4
- 1 x USB cable
- 1 x aluminium carrying case
- 1 x lithium-ion battery
- 1 x mains adaptor
- 1 x wrist band
- 1 x calibration plate (white)
- 1 x pc software
- 1 x instruction manual

4 System description

4.1 Button description



- 1. On/Off button
- 2. Menu button
- 3. Up button
- 4. Down button

- 5. Enter button
- 6. Back button
- 7. Testing button

4.2 Interface description

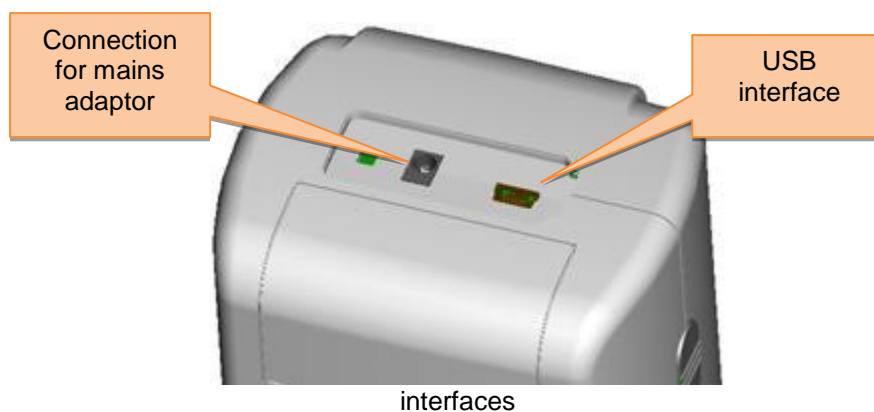

- Mains adaptor: Only use the mains adaptor included in the package. If it breaks down, only use substitutions with the following characteristics: output 5 V DC, 2 A.
- USB interface: By using the USB interface, you can transfer data from the colorimeter to a PC. The baud rate is 115,200 bps.

4.3 Battery

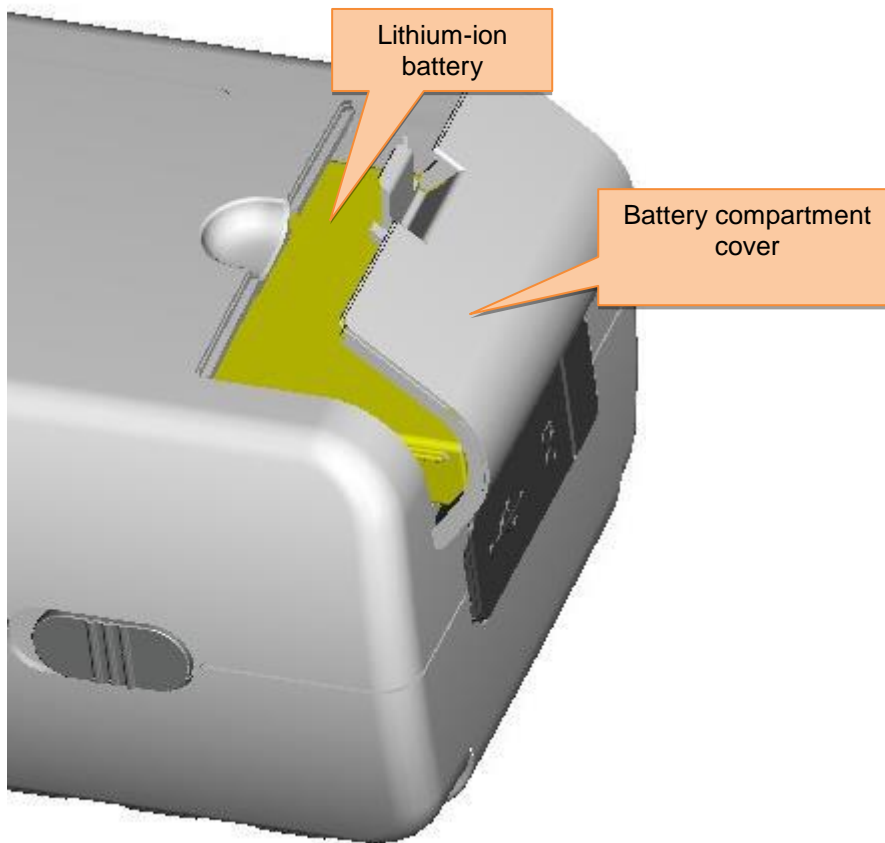

Installing the battery

1. Make sure the device is turned off.
2. Open the battery compartment cover.
3. Put the battery in the allocated space.
4. Close the battery compartment cover.

Charging the battery

The battery can only be charged when the device is connected to a PC or to the mains adaptor.

Note: If the battery is damaged, the device can still be used via an external power source (PC / mains adaptor).

4.4 Changing the measuring aperture (only PCE-CSM 1)

Installing the measuring aperture

To install the measuring aperture, first put it in the allocated space (see picture below). Now turn it counter-clockwise until you hear a clicking noise. This means that the measuring aperture is now attached properly.



Detaching the measuring aperture

To dismantle the measuring aperture, turn it clockwise, until you hear a clicking noise. This means, it is now detached.

5 Operation

5.1 Turn on the device

1. Make sure the battery is installed or the device is connected to an external power source.
2. Turn on the device by switching the On/Off button to "1". After a few seconds, you are automatically directed to the "Standard Measurement" screen. The default setting for this measuring mode is $L^*a^*b^*C^*H$.

5.2 Taking a measurement

If you turn on the device, you are directed to the "Standard Measurement" screen. To take a measurement, follow these steps:

1. Press and hold the testing button (see chapter 4.1). Next, 4 light cones appear to help you aim at the measuring point.
2. Move the device as close to the measuring point as possible.
3. Release the testing button. The colorimeter now takes a measurement.

After the measuring process is finished, you can see the results in the following display:

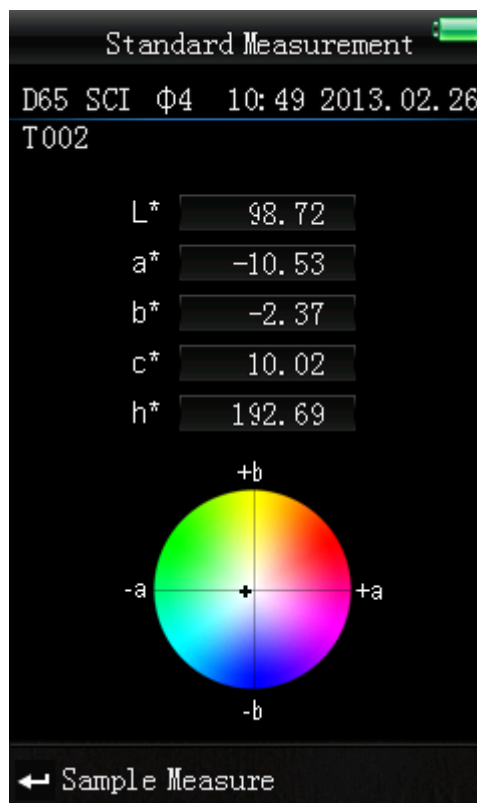

After taking a “Standard Measurement”, you can also take one or more “Sample Measurements”. To do so, follow these steps:

1. When in the result screen of a standard measurement, press the Enter button \blacktriangleleft . You are now redirected to the “Sample Measurement” display.
2. Take another measurement (just like you took the standard measurement).
3. Now you can see the deviation of the sample in the following display:

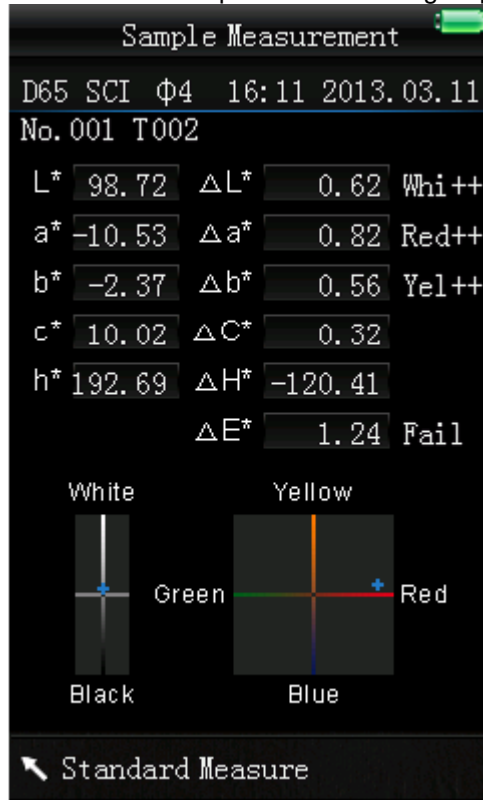

Note: While the measurement is in progress (time duration: ~ 1 second), all buttons are inactive.

To go back to the “Standard Measurement” display, press the Back button \blacktriangleleft .

5.3 Additional functions

5.3.1 Record

All measuring results are recorded and saved to the internal memory of the colorimeter. To view the recorded data, press the Menu button \equiv , select "Record" and press Enter \leftarrow to confirm.



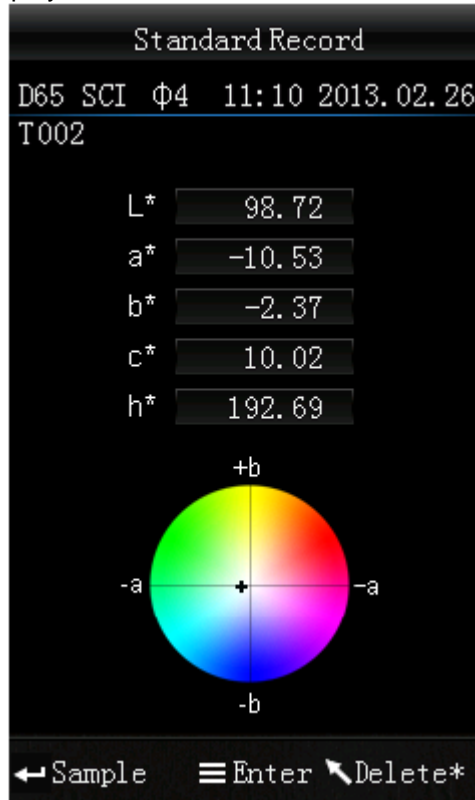

Now, you get to the following display:



Here, you can navigate between the individual measurements by using the arrow keys (\uparrow and \downarrow).

- If you took one or more sample measurements, you can view those measurements by pressing Enter \leftarrow . You can navigate through the sample measurements by using the arrow keys (\uparrow and \downarrow).
If you want to delete a sample measurement, select it and press and hold the Back button \leftarrow , until a confirmation display appears. Now, press Enter \leftarrow to delete the sample or press Back \leftarrow to cancel.
By pressing Back \leftarrow again, you can go back to the standard record display.
- If you want to add sample measurements to a standard measurement subsequently, select the standard measurement and press the Menu button \equiv . Now, you are in the measurement display. Press Enter \leftarrow to get to the sample measurement display. Now you can take sample measurements which are added to the selected standard measurement.

5.3.2 Calibration

To get to the calibration menu, press the Menu button , select "Calibrate" and press Enter . Here you can select between white and black calibration. Use the arrow keys ( and ) to select and press Enter  to confirm. A confirmation display with instructions will appear.

White calibration



If you want to perform a white calibration, place the white calibration plate on the measuring aperture. After that, press the Testing button to start the calibration.

Black calibration

If you wish to perform a black calibration, remove the calibration plate and place the device with the measuring aperture oriented upwards. Make sure that this calibration is carried out in a dark environment. Additionally, keep the device away at least 1 meter from reflecting objects like walls, tables or other objects. To start the calibration process, press the Testing button.

Note: A calibration is only reasonable in the following cases: when first using the device, after strong changes in the environmental conditions, when the device has been used for a long time or when the measurement results are inaccurate.

5.3.3 Connection to a PC or printer



To connect the device to a PC or printer, press the Menu button , select "Comm" and press Enter . Now, you will get to the communication display.







After that, use the USB cable to connect the device to a PC and press Enter . If the connection was successful, the screen shows "Communicating..."



The device can also be connected to a printer. In this case, all measuring results are printed automatically.



5.3.4 Tolerances

To set up or adjust tolerances, press the Menu button , select "Tolerance" and press Enter . Now, you get to the tolerance display.





Here you can activate / deactivate different tolerances. To do so, select the desired option by using the arrow keys ( and ) and press Enter . If you activate a tolerance, you get to an input display where you can set the desired threshold value. Use the arrow keys ( and ) to select a number. Press Enter  to get to the next digit. After confirming the last digit by pressing Enter , the tolerance is set up.

Note: The threshold value refers to the „ ΔE^ “ value in the sample measurement display. It specifies the maximum acceptable value of the deviation. If the measured value exceeds the threshold value, you can see a "Fail" indication in the display. Otherwise, the display will show "Pass".*

5.3.5 Delete recorded data

To delete the recorded data, press the Menu button , select "Delete" and press Enter . Now, you get to the delete display.



Here you have two different options. You can either delete all sample measurements ("Delete ALL Samples") or all records ("Delete ALL Records").



Select the desired option by using the arrow keys ( and ) and press Enter . A confirmation display appears. Press Enter  to confirm or Back  to cancel.

Note: If you delete all records, all sample measurements will be deleted as well.

5.3.6 Averaging

You can set the number of measurements which are performed during the measuring procedure. From these particular measurement results, the average value is generated.

To get to the averaging settings, press the Menu button , select "Average" and press Enter .

Here, you can set the number of measurements. Use the arrow keys to select a number. Press Enter  to get to the next digit. After confirming the last digit by pressing Enter , the averaging is set.

Note: If you set "00" or "01", there will be no averaging.

5.3.7 Display mode

To change the display mode, press the Menu button \equiv , select "Display" and press Enter \leftarrow . Now, you get to the display mode settings.

Here you have three different options: "CIE L*a*b*C*H*", "CIE L*a*b*" and "CIE XYZ". Use the arrow keys (\uparrow and \downarrow) to select the desired option and press Enter \leftarrow to confirm.

The following images show the different display modes:

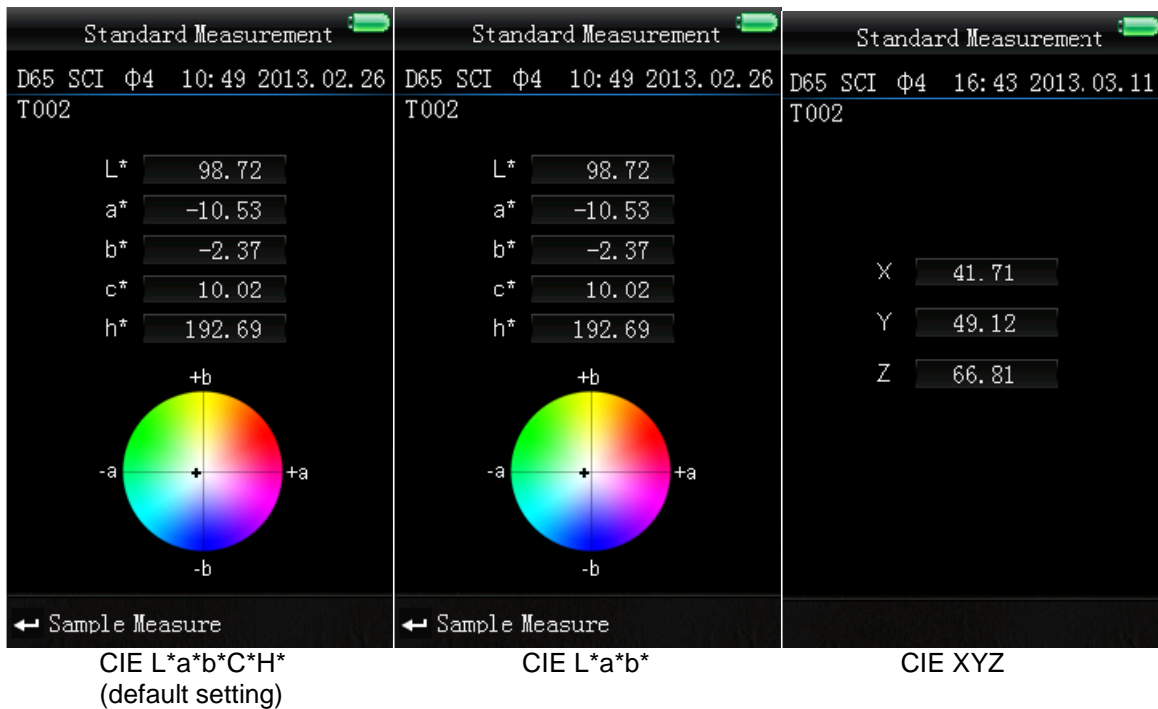

6 Settings

To get to the settings, press the Menu button \equiv , select "Setting" and press Enter \leftarrow . Here you have different options. Use the arrow keys (\uparrow and \downarrow) to navigate and confirm the selection by pressing Enter \leftarrow .

6.1 Colour offset

Here you can activate / deactivate the colour offset. Use the arrow keys (\uparrow and \downarrow) for selection and confirm by pressing Enter \leftarrow .

6.2 Language

Here you can select the menu language of the device. You can choose between English and Chinese. Select the desired language by means of the arrow keys (\uparrow and \downarrow) and confirm by pressing Enter \leftarrow .

6.3 Time setting

Here you can set the time ("Set time"), date ("Set date") and how time and date are displayed ("Time format" / "Date format"). Select the desired option by using the arrow keys (\uparrow and \downarrow) and press Enter \leftarrow to confirm.

Set time / date

Here you can set the individual digits of the time and date. Adjust the particular number by using the arrow keys (\uparrow and \downarrow) and press Enter \leftarrow to get to the next digit. After confirming the last digit by pressing Enter \leftarrow , the time / date is set.

Time format

Here you can choose between 24 h format and 12 h format. Use the arrow keys (↑ and ↓) for selection and press Enter ↵ to confirm.

Date format

Here you can choose between year-month-day, month-day-year and day-month-year. Use the arrow keys (↑ and ↓) for selection and press Enter ↵ to confirm.

6.4 Contrast

Here you can adjust the contrast of the display. Use the arrow keys (↑ and ↓) to adjust the scroll bar and press Enter to confirm ↵.

6.5 Restore factory settings

Here you can restore the factory settings of the device. To do so, press Enter ↵ in the confirmation display. To cancel, press Back ↶.

7 Optional Accessories

7.1 Powder test box PCE-CSM PTB

With the optional powder test box PCE-CSM PTB you can determine the colorimetric parameters of powders.

7.1.1 Build-up

The PCE-CSM PTB is built up of a base plate (1), a measuring plate with a powder compartment (2), a lens (3) and a mounting ring (4).

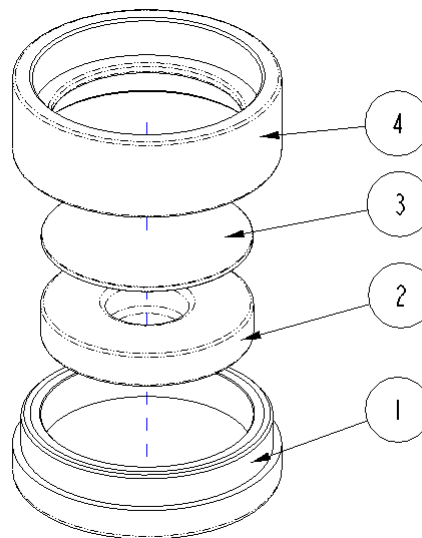

7.1.2 Operation

1. **Calibration:** Put the lens on the white calibrations plate and perform a white calibration. After that, perform a black calibration.
2. **Fill in the powder:** Fill the powder into the powder compartment of the measuring plate.

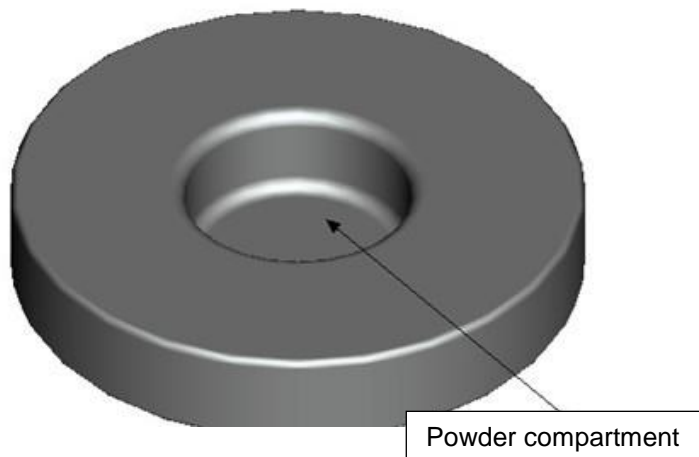

After that, put the powder test box back together (see 7.1.1). Make sure the screw joint is straight.

3. **Measure:** Place the measuring hole of the colorimeter on the hole of the powder test box and perform a measurement. Make sure the colorimeter is stable.
4. **Clean the test box:** After using the powder test box, disassemble and clean it. If needed, you can use alcohol for cleaning. After the cleaning, let the box dry and store it properly until the next use.

8 Contact

If you have any questions about our range of products or measuring instruments please contact PCE Instruments.

8.1 PCE Instruments UK

By post:

PCE Instruments UK Ltd.
Units 12/13 Southpoint Business Park
Ensign Way, Southampton
Hampshire

United Kingdom, SO31 4RF

By phone:

02380 987 035

8.2 PCE Americas

By post:

PCE Americas Inc.
711 Commerce Way
Suite 8
Jupiter
33458 FL
USA

By phone:

561 320 9162

