



Tursdale Technical Services Ltd
Unit N12B
Tursdale Business Park
Co. Durham
DH6 5PG
United Kingdom
Phone: +44 (0) 191 377 3398
Fax: +44 (0) 191 377 3357
info@tursdaletechnicalservices.co.uk
<http://www.industrial-needs.com/>

Manual PCE 228



TABLE OF CONTENTS

1. FEATURES.....	1
2. SPECIFICATIONS.....	2
3. FRONT PANEL DESCRIPTION.....	4
4. PH CALIBRATING PROCEDURE.....	6
4-1 Calibrating Consideration.....	6
4-2 Requiring Equipment for calibration.....	6
4-3 Two Points Calibration.....	6
4-4 Signal Point Calibration.....	8
4-5 Others.....	9
5. PH TEMPERATURE COMPENSATION.....	10
5-1 Manual temperature compensation.....	10
5-2 Automatic temperature compensation.....	14
6. MEASURING PROCEDURE.....	14
6-1 PH Measurement.....	14
6-2 mV Measurement.....	15
6-3 Temp. Measurement.....	15
7. AUTO POWER DISABLE.....	18
8. RS232 PC SERIAL INTERFACE.....	18
9. BATTERY REPLACEMENT.....	20
10. OPTIONAL PROBES & ACCESSORIES.....	20

1. FEATURES

- * Professional PH/mV METER.
PH range : 0 to 14 PH x 0.01 PH.
mV range : -1999 mV to 1999 mV.
- * The instrument is with mV (millivolt) function for mV measurement (cooperate with optional ORP probe to be a professional ORP meter)
- * Wide manual temperature compensation adjustment can be easily operated by push button on the front panel.
- * Optional ATC (Automatic Temp. Compensation) probe is available for PH measurement.
- * Microprocessor circuit assures high accuracy and reliable performance.
- * Large LCD, dual function display.
- * Records Maximum and Minimum readings with recall.
- * Data hold.
- * Auto shut off saves battery life.
- * Powered by 006P DC 9V battery.
- * RS 232 computer serial interface.
- * °C or °F can be converted by push button on the front panel.
- * PH calibration is easily to be done by push button on the front panel.
- * Using the durable, long-lasting components and a strong lightweight ABS-plastic housing case.
- * PH function with high input impedance avoids measuring error.
- * Wide applications: water conditioning, aquariums, beverage, fish hatcheries, food processing, photography, laboratory, paper industry, plating industry, quality control, school & college.

2. SPECIFICATIONS

2-1 General Specifications

Circuit	Custom one-chip of microprocessor LSI circuit.	
Display	51 mm x 32 mm, dual function LCD display, 15 mm (0.6") digit size.	
Measurement	PH	0 to 14 PH
	mV	-1999 mV to 1999 mV
Input Impedance	10 [^] 12 ohm	
Temperature Compensation for pH measurement	Manual	0 to 100 °C, be adjusted by push button on front panel.
	Automatic (ATC)	With the optional TEMP. probe (TP-07) 0 to 65 °C.
pH Calibration	PH7, PH4, and PH10, 3 points calibration ensure the best linearity and accuracy.	
Data hold	Hold the current reading value on the display.	
Memory Recall	Maximum and Minimum reading values can be saved and retrieved by record function.	
Power off	Auto shut off saves battery life, or manual off by push button.	
Data Output	RS 232 computer serial interface.	
Overload indication	"- - - -" symbol on the display.	
PH Electrode	Optional, Any PH electrode with BNC connector.	
Operating Temperature	0 °C to 50 °C (32 °F to 122 °F).	

Operating Humidity	Max. 80% RH.
Sampling Time	Approx. 0.8 second.
Power Supply	006P DC 9V battery (<i>Alkaline or Heavy duty type</i>).
Power Current	Approx. DC 7 mA.
Weight	250 g/0.55 LB (battery included).
Size (meter)	195 x 68 x 30 mm (7.6 x 2.6 x 1.2 inch).
Standard Accessories	Instruction manual.....1 PC.
Optional Probes & Accessories (Ref. page 20)	PH electrodes : <ul style="list-style-type: none"> * <i>General purpose PH electrode, PE-03</i> * <i>General purpose PH electrode, PE-11</i> * <i>Professional PH electrode, PE-01</i> * <i>Spear tip PH electrode, PE-04HD, PE-06HD</i> ATC temp. probe, TP-07 PH electrodes + Temp. Probe, PE-03K7 ORP electrode, ORP-14 Hard carrying case, CA-06 RS232 cable, UPCB-02 RS232 cable, USB-01 Application Software, SW-U801-WIN

2-2 Electrical Specifications (23 ± 5 °C)

Measurement	Range	Resolution	Accuracy
PH	0 to 14 PH	0.01 PH	± (0.02 PH + 2 d)
mV	0 to 1999 mV	1 mV	± (0.5% + 2 d)
* <i>PH accuracy is based on calibrated meter only.</i> * <i>Specification tests under the environment RF Field Strength less than 3 V/M & frequency less than 30 MHz only.</i>			

3. FRONT PANEL DESCRIPTION

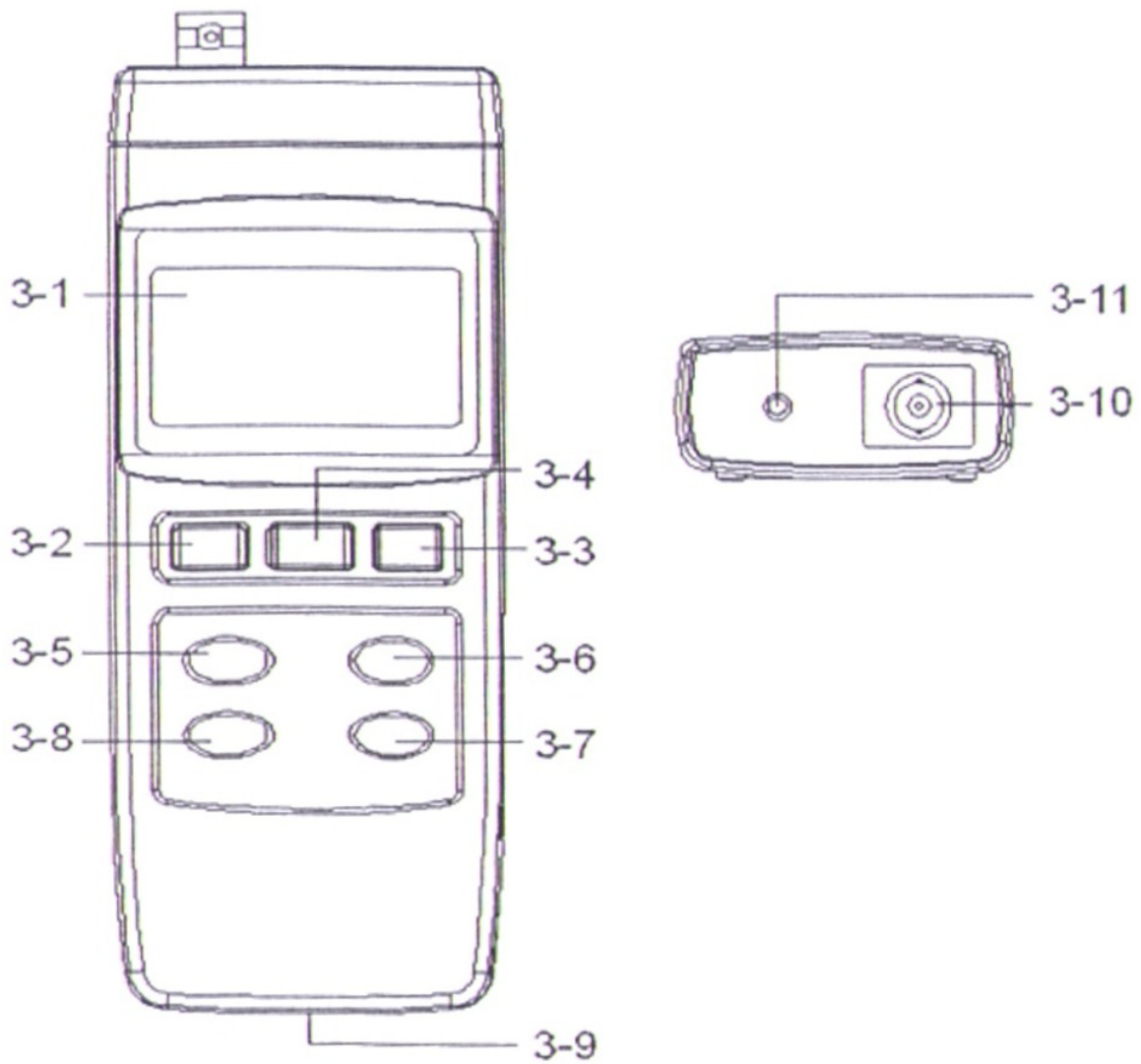

Fig. 1

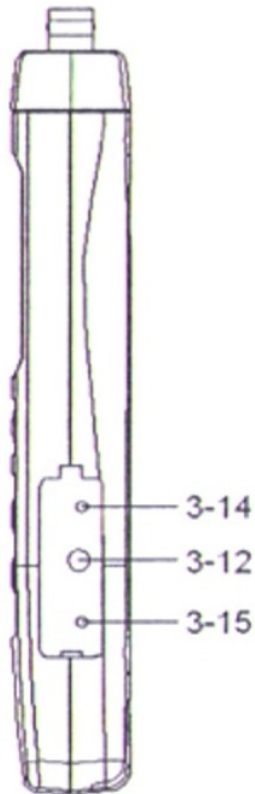

Fig. 2

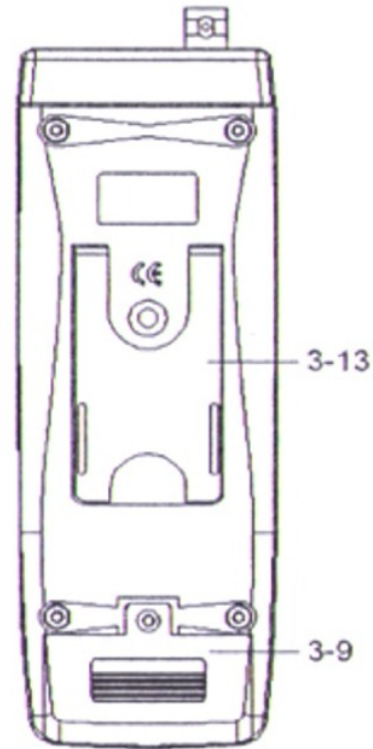

Fig. 3

- 3-1 Display
- 3-2 Power Button
- 3-3 REC. Button
- 3-4 Hold Button
- 3-5 °C, °F Button/Up Button
- 3-6 PH/mV Button/Left Button
- 3-7 TEMP. C Button
- 3-8 CAL Button/Down Button
- 3-9 Battery Compartment/Cover
- 3-10 PH BNC Input Socket
- 3-11 ATC Probe Input Socket
- 3-12 RS-232 Out Terminal
- 3-13 Stand
- 3-14 PH 7 VR
- 3-15 PH 4/PH 10 VR

4. PH CALIBRATION PROCEDURE

4-1 Calibration Consideration

The most ideal PH ELECTRODE generates 0 mV at PH 7.00 (177.4 mV at PH 4) and PH-208 has been always calibrated with signals which simulate the most ideal PH ELECTRODE (based on 25°C ambient environment). However not every PH ELECTRODE is as accurate as the most ideal one, so calibration procedures are necessary to be done before the first time measurement. In addition to the first time measurement, users are also recommended to execute the calibration procedures to ensure the high accuracy measurement.

4-2 Required Equipment for Calibration

- 1) PH ELECTRODE (optional).
- 2) PH buffer solutions (optional).

4-3 Two Points Calibration Procedure

- 1) Power on the instrument by pressing the " Power Button " (3-2, Fig. 1).
- 2) Press the " PH/mV Button " (3-6, Fig. 1) to let meter be operated under the PH function with a " PH " symbol on the display.
- 3) Adjust the " Temperature Compensation Value " to make it same as the temperature value of the pH buffer solution.

Manual temperature compensation value adjustment procedure, please refer to 5-1 (Page 10).

Automatic temperature compensation value adjustment procedure, please refer to 5-2 (Page 14).

4) **PH 7 calibration**

Connect the PH ELECTRODE with the " BNC socket " (3-10, Fig. 1) and immerse the electrode in the PH7 buffer solution.

Press the " CAL Button " (3-8, Fig. 1) then the upper display shows texts of " CAL " and the lower display shows the default calibration value.

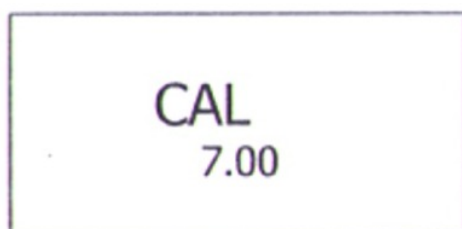

- * The texts " CAL " will flash for around 5 seconds. After that, the meter calibrates itself automatically. The upper display will show the calibrated value, the lower display will show the temperature value.

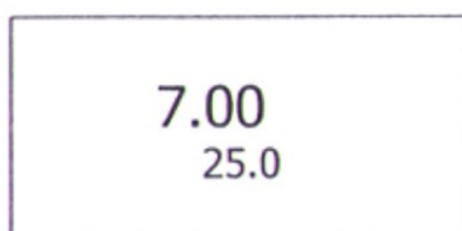

5) **PH 4 or PH 10 calibration**

Rinse the electrode with distilled water.

Immerse the electrode in the PH4 buffer solution (or PH10 buffer solution).

Press the " CAL Button " (3-8, Fig. 1) then the upper display shows texts of " CAL " and the lower display shows the default calibration value.

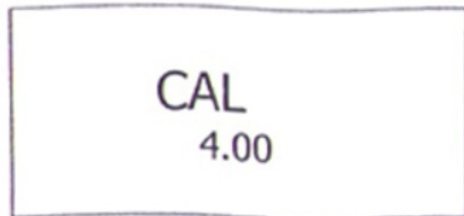

- * The texts " CAL " will flash for around 5 seconds. After that, the meter calibrate itself automatically. The upper display will show the calibrated value, the lower display will show the temperature value.

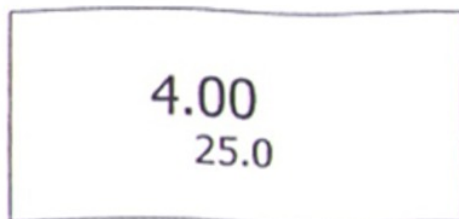

- 6) Rinse the electrode with distilled water again.
- 7) Repeat above (4) to (5) procedures two times at least.
- 8) The instrument and electrode are now finished the " TWO POINTS CALIBRATION " & ready for the measurement.

4-4 Signal Point Calibration

If PH4 and PH10 buffer solution are not available, single point (PH7) calibration can be executed from procedures of 4-3 (1) to (4). However for more accurate measuring result and linearity, two points calibration is always recommended.

4-5 Others

Above calibration procedures effect only when reading value within 1 PH of the calibration point.

However if the reading value beyond

- * 1 PH of PH 7 (> PH8, < PH6)**
- * 1 PH of PH 4 (> PH5, < PH3)**
- * 1 PH of PH 10 (> PH11, < PH9)**

the calibration procedures are :

- 1) Connect the PH ELECTRODE to the " PH BNC Input Socket " (3-10, Fig. 1).
- 2) Power on the instrument by pressing the " Power Button " (3-2, Fig. 1).
- 3) Press the " PH/mV Button " (3-6, Fig. 1) to select the PH function with a "PH" symbol on the display
- 4) Set the " Manual temperature compensation " value to 25 °C refer to 5-1 calibration procedures, page 10.
- 5) Place the electrode into the standard solution (PH7, PH4 or PH10) , then the instrument will have the PH value on the display.
- 6) * For measuring the PH7 standard solution, adjust the PH 7 VR (3-14, Fig. 3) until the display value within PH6 to PH8.
 - * For measuring the PH4 standard solution, adjust the PH 4 VR (3-15, Fig. 3) until the display value within PH3 to PH5.
 - * For measuring the PH10 standard solution, adjust the PH 10 VR (3-15, Fig. 3) until the display value within PH9 to PH11.
- 7) The following calibration procedures will be same as 4-3 (page 6) and 4-4 (page 8).

5. PH TEMPERATURE COMPENSATION

Enable the meter to gain high accuracy measuring results from different kinds of solution, the temperature compensation calibration procedures are necessary to be executed.

Manual temperature compensation calibration procedures please refer to 5-1 (See below).

Automatic temperature compensation calibration procedures please refer to 5-2 (Page 14).

5-1 Manual temperature compensation procedures

Before the manual temperature compensation calibration procedures, please make sure there are no ATC probe (TP-07) in the " Optional Probe Input Socket" (3-11, Fig. 1).

- 1) Power on the instrument by pressing the " Power Button " (3-2, Fig. 1).
- 2) Press the " PH/mV Button " (3-6, Fig. 1) to select the PH function with a " PH " symbol on the display
- 3) " TEMP. C Button " (3-7, Fig. 1) is used to adjust the following values :

- | |
|--|
| <ol style="list-style-type: none">a. Temperature compensation valueb. PH 4 Default calibration valuec. PH 7 Default calibration valued. PH 10 Default calibration value |
|--|

a. Adjust the temperature compensation value

- * **Press the " TEMP. C Button " (3-7, Fig. 1) first,**
The upper display will show the measured PH values.
the lower display will show the manual temperature compensation value.

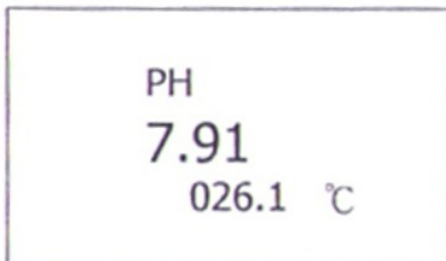

- @ Use the " Left Button " (3-6, Fig. 1), " Up Button " (3-5, Fig. 1) and the " Down Button " (3-8, Fig. 1) to adjust the manual temperature compensation value.

b. Adjust the PH 4 default calibration value

- * **When the manual temp. compensation values be adjusted. Press the " TEMP. C Button " (3-7, Fig. 1) once again to adjust the PH 4 default calibration value.**
The upper display will show the values of " 4.00 " and the lower display will show the " PH 4 default calibration value ".

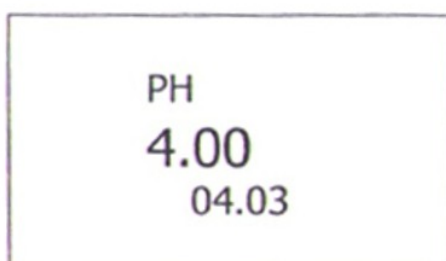

@ Use the " Up Button " (3-5, Fig. 1) and the " Down Button " (3-8, Fig. 1) to adjust the PH 4 default calibration value.

@ The adjustment range of " PH4 default calibration value " is limited within 4.00.20 PH

c. Adjust the PH 7 default value

*** When the PH 4 default value be adjusted. Press the " TEMP. C Button " (3-7, Fig. 1) once again to adjust the PH 7 default calibration value.**

The upper display will show the values of " 7.00 " and the lower display will show the " PH 7 default calibration value ".

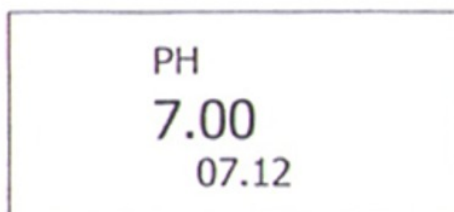

@ Use the " Up Button " (3-5, Fig. 1) and the " Down Button " (3-8, Fig. 1) to adjust the PH 7 default calibration value.

@ The adjustment range of " PH 7 default calibration value " is limited within 7.00.20 PH.

d. Adjust the PH 10 Default Value

*** When the PH 7 default calibration value be adjusted. Press the " TEMP. C Button " (3-7, Fig. 1) once again to adjust the PH 10 default calibration value.**

The upper display will show the values of " 10.00 " and the lower display will show the " PH 10 default calibration value ".

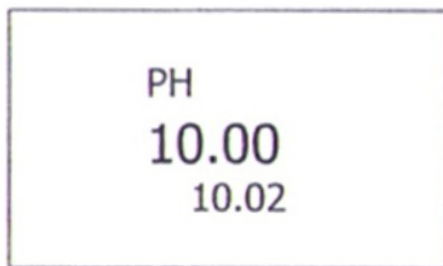

- @ Use the " Up Button " (3-5, Fig. 1) and the " Down Button " (3-8, Fig. 1) to adjust the PH 10 default calibration value.
- @ The adjustment range of " PH10 default calibration value " is limited within 10.00.20 PH

e. Finish the adjustment

- * **When the PH 10 default calibration value be adjusted, press the " TEMP. C Button " (3-7, Fig. 1) once again to finish the manual temperature calibration procedures and return to the measuring mode.**

Consideration :

If you want to skip any procedures above, just press " Temp. C Button " (3-7, Fig. 1).

Above PH default calibration values you set will become the default value when you execute the PH Calibration Procedure. It is very convenient for user when PH 4.00, PH 7.00, and PH 10.00 buffer solution are not available.

5-2 Automatic temperature compensation

- 1) Plug the " Optional ATC Temp. Probe, TP-07 " into the " ATC Probe Input Socket " (3-11, Fig. 1).
- 2) Power on the instrument by pressing the " Power Button " (3-2, Fig. 1).
- 3) Press the " PH/mV Button " (3-6, Fig. 1) to select the PH function with a "PH" symbol on the display
- 4) Place the "Temp. Probe" into the solution, and then temperature will be compensated automatically for PH measurement.

6. MEASURING PROCEDURE

6-1 PH Measurement

Whenever the calibration procedures are recommended to be done before PH measurement.

- 1) Connect the PH ELECTRODE to the " PH BNC Input Socket " (3-10, Fig. 1).
- 2) Power on the instrument by pressing the " Power Button " (3-2, Fig. 1).
- 3) Press the " PH/mV Button " (3-6, Fig. 1) to select the PH function with a "PH" symbol on the display.

- 4) * If the operating is under the " Manual temperature compensation ", then please refer to the above 5-1 calibration procedures.
* If the operating is under the " Automatic temperature compensation ", then please refer to the above 5-2 calibration procedures.
- 5) Place the electrode into the solution, then the instrument will have the PH value on the display.
- 6) After the measurement, please rinse the electrode with distilled water.

6-2 mV Measurement

The instrument build in mV (millivolt) measurement function, which enable you to make ion-selective, ORP (oxidation-reduction potential), and other precise mV measurements.

Press the " PH/mV Button " (3-6, Fig. 1) to select the mV function with a " mV " symbol on the display.

6-3 Temp. Measurement

- 1) Plug the " Optional ATC Temp. Probe, TP-07 " into the " Optional Probe Input Socket " (3-11, Fig. 1).
- 2) * If you intend to measure " °C ", then press the " °C / °F Button " (3-5, Fig. 1) and select the " °C " unit.
* If you intend to measure " °F ", then press the " °C / °F Button " (3-5, Fig. 1) and select the " °F " unit.
- 3) Place the " Temp. Probe " into the solution, and the instrument will have the temperature value on the display.

6-4 Data Hold

Press the " Hold Button " (3-4, Fig. 1) will hold the measured value & the LCD will indicate a " HOLD " symbol on the display during the measuring.

* *Press the " Hold Button " again to exit the data hold function.*

6-5 Data Record (Max., Min. reading)

* The data record function records the maximum and minimum readings. Press the " REC. Button " (3-3, Fig. 1) to start the Data Record function and there will be a " REC " symbol on the display.

* With the " REC " symbol on the display :

a) Press the " REC. Button " (3-3, Fig. 1) once, the " REC Max " symbol along with the maximum value will appear on the display.

If you intend to delete the maximum value, just press the " Hold Button " (3-4, Fig. 1) for a while, then the display will show the " REC " symbol only & execute the memory function continuously.

b) Press the " REC. Button " (3-3, Fig. 1) again, the " REC Min " symbol along with the minimum value will appear on the display.

If you intend to delete the minimum value, just press the " Hold Button " (3-4, Fig. 1) for a while, then the display will show the " REC " symbol only & execute the memory function continuously.

c) To exit the memory record function, just press the " REC " button for 2 seconds at least. The display will revert to the current reading.

6-6 Following are the block diagrams for quick measuring procedures

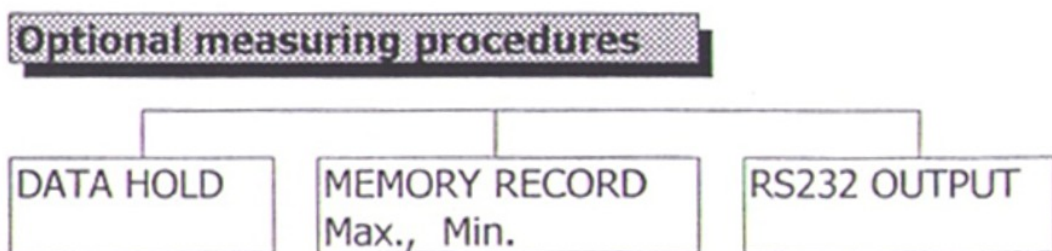
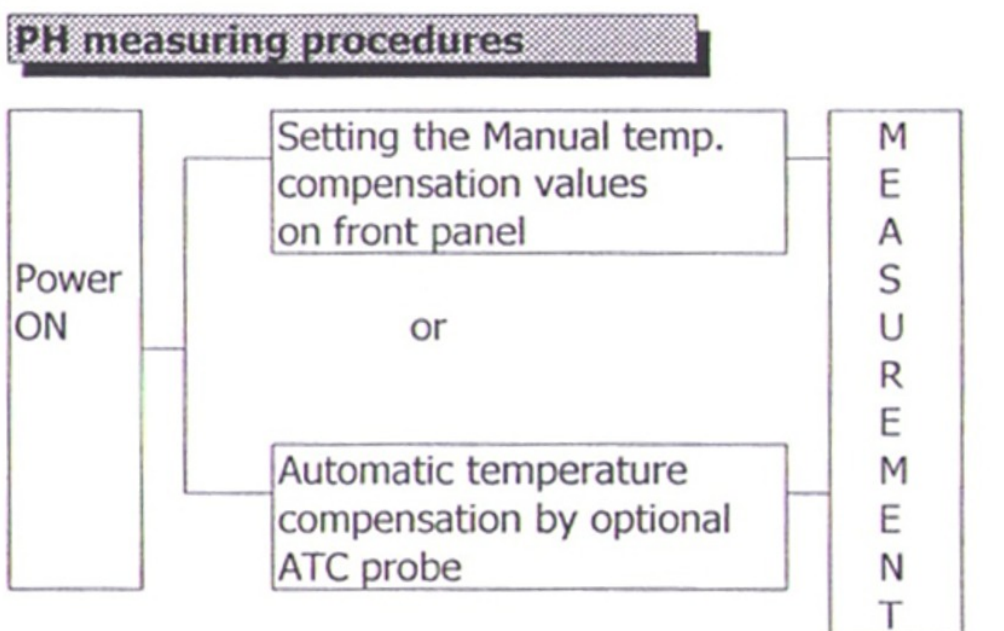
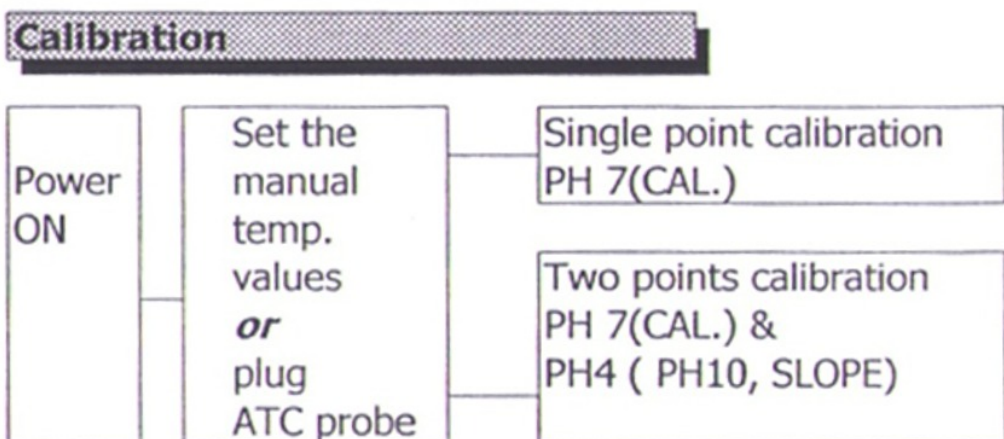

Power management

AUTO POWER OFF

(Not available during
Memory Record Function)

or

MANUAL POWER OFF

7. AUTO POWER OFF DISABLE

The instrument has " Auto Power Off " function in order to prolong battery life. The meter will shut off automatically if none of the buttons are pressed in approx. 10 min.

To disable this function, select the memory record function during the measurement by pressing the " REC. Button " (3-3, Fig. 1).

8. RS232 PC SERIAL INTERFACE

The instrument features RS232 output via 3.5 mm Terminal (3-12, Fig. 3).

The signals output is a 16 digits data stream which can be utilized for user's specific application.

A RS232 lead with the following connection will be required to link the instrument with the PC serial interface.

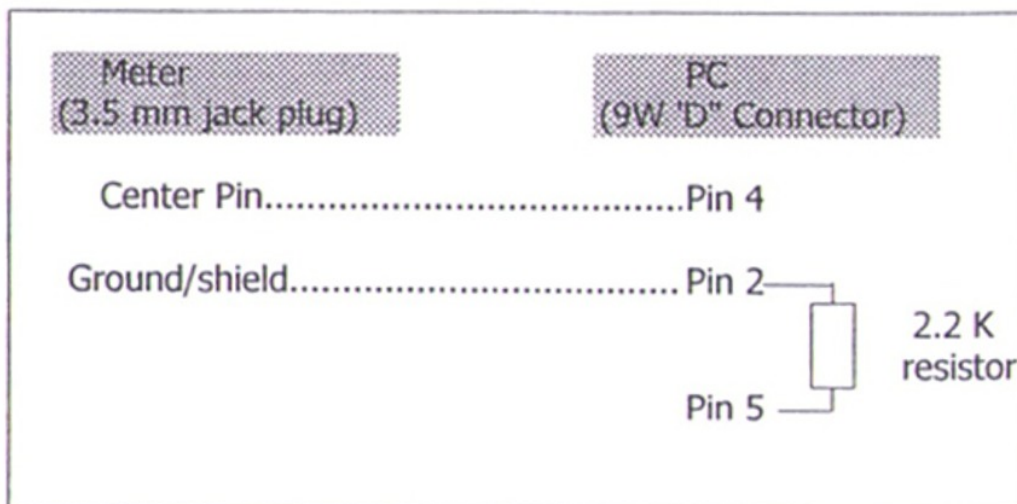

The 16 digits data stream will be displayed in the following format :

D15 D14 D13 D12 D11 D10 D9 D8 D7 D6 D5 D4 D3 D2 D1 D0

Each digit indicates the following status :

D15	Start Word		
D14	4		
D13	When send the upper display data = 1 When send the lower display data = 2		
D12, D11	Annunciator for Display		
	°C = 01	°F = 02	PH = 05
	mV = 18	mS = 14	PPM = 19
	O2 = 06	mg/L = 07	
D10	Polarity 0 = Positive 1 = Negative		
D9	Decimal Point(DP), position from right to the left 0 = No DP, 1= 1 DP, 2 = 2 DP, 3 = 3 DP		
D8 to D1	Display reading, D8 = MSD, D1 = LSD <i>For example :</i> <i>If the display reading is 1234, then D8 to D1 is :</i> <i>00001234</i>		
D0	End Word		

RS232 setting

Baud rate	9600
Parity	No parity
Data bit no.	8 Data bits
Stop bit	1 Stop bit

9. BATTERY REPLACEMENT

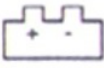
- 1) When the left corner of LCD display show "  ", it is necessary to replace the battery. However, in-spec. measurement may still be made for several hours after low battery indicator appears.
- 2) Slide the " Battery Cover " (3-14, Fig. 1) away from the instrument and remove the battery.
- 3) Replace with 9V battery (Alkaline or Heavy duty type) and reinstate the cover.
- 4) Make sure the battery cover is secured after changing the battery.

10. OPTIONAL PROBES & ACCESSORIES

ATC PROBE Model : TP-07	* ATC (Automatic Temperature Compensation) Probe for PH function. <table border="1" data-bbox="738 1552 1276 1680"> <thead> <tr> <th>Measurement</th> <th>Range</th> </tr> </thead> <tbody> <tr> <td>°C</td> <td>0 °C to 65 °C</td> </tr> <tr> <td>°F</td> <td>32°F to 149 °F</td> </tr> </tbody> </table>	Measurement	Range	°C	0 °C to 65 °C	°F	32°F to 149 °F
Measurement	Range						
°C	0 °C to 65 °C						
°F	32°F to 149 °F						
CARRYING CASE CA-06	Hard carrying case						
ORP ELECTRODE Model : ORP-14	Select to the mV function, plug the ORP electrode into the BNC socket to become a professional ORP (oxidation-reduction potential) Meter.						

PH ELECTRODE Model : PE-03	General purpose, laboratory & field usage. 12.3 mm dia. x 160 mm. Epoxy body, 1 - 13 pH.
PH ELECTRODE Model : PE-11	General purpose, laboratory & field usage. 10 mm dia. x 130 mm. Epoxy body, 1 - 13 pH. (0 - 14 pH typical)
PH ELECTRODE Model : PE-01	Professional, laboratory & field usage. 9.5 mm dia. x 130 mm. Epoxy body, 0 - 14 pH.
SPEAR TIP PH ELECTRODE Model : PE-04HD PE-06HD	The "Spear Tip pH electrode" is perfect for those pH measurements in applications where sample piercing is required. Meat, sausage and cheese are ideal applications. The electrode features a very durable glass measuring spear packaged in a rugged virtually unbreakable epoxy body. Range : 0 to 14 pH (PE-04HD) Range : 1 to 13 pH (PE-06HD)
BUFFER SOLUTION PH-07	PH 7.00 standard buffer solution. for calibration purpose.
BUFFER SOLUTION PH-04	PH 4.00 standard buffer solution. for calibration purpose.
RS232 cable UPCB-02	RS232 cable for connecting between the meter & the computer.
SOFTWARE SW-U801-WIN	Windows version application software applies as the performance of data logging system & data recorder...



info@tursdaletechnicalservices.co.uk

In this direction will find a vision of the measurement technique:
<http://www.industrial-needs.com/measuring-instruments.htm>

NOTE: "This instrument doesn't have ATEX protection, so it should not be used in potentially explosive atmospheres (powder, flammable gases)."